

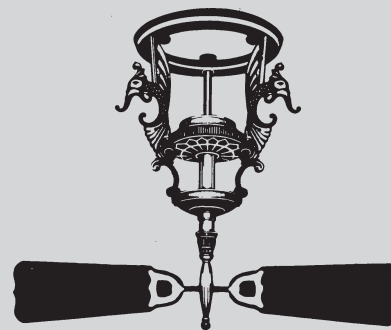

SINCE

1886

Installation and Operation Manual For Hunter Ceiling Fans







CONGRATULATIONS!

Your new Hunter ceiling fan is an addition to your home or office that will provide comfort and performance for many years. This manual gives you complete instructions for installing and operating your fan.

We are proud of our work. We appreciate the opportunity to supply you with the best ceiling fan available anywhere in the world.

Before installing your fan, record the following information for your records and warranty assistance. Please refer to the carton and the Hunter nameplate (located on top outside fan motor housing) for the proper information.

Model Name _____
Catalog No. _____
Serial No. _____
Date Purchased _____
Where Purchased _____

Attach Your Receipt
or a Copy of
Your Receipt Here



CONTENTS

| | |
|---|----|
| Important Information | 5 |
| Step 1 - Getting Ready | 6 |
| Step 2 - Installing the Ceiling Plate | 8 |
| Step 3 - Assembling the Fan | 11 |
| Step 4 - Installing the Blade Irons | 14 |
| Step 5 - Wiring the Fan | 15 |
| Step 6 - Installing the Canopy | 18 |
| Step 7 - Assembling Fan Blades | 19 |
| Step 8 - Attaching The Switch Housing | 20 |
| Step 9 - Installing Light Fixture | 23 |
| Operating Your Hunter Fan | 26 |
| Cleaning and Maintenance | 27 |
| Troubleshooting | 28 |



IMPORTANT INFORMATION

⚠ CAUTIONS

- Read entire booklet carefully before beginning installation and save these instructions.
- To reduce the risk of personal injury, attach the fan directly to the support structure of the building according to these instructions, and use only the hardware supplied.

⚠ WARNINGS

- To avoid possible electrical shock, before installing your fan, disconnect the power by turning off the circuit breakers to the outlet box and associated wall switch location. If you can-

not lock the circuit breakers in the off position, securely fasten a prominent warning device, such as a tag, to the service panel.

- All wiring must be in accordance with national and local electrical codes. If you are unfamiliar with wiring, you should use a qualified electrician.
- To reduce the risk of personal injury, do not bend the blade attachment system when installing, balancing, or cleaning the fan. Never insert foreign objects between rotating fan blades.
- The fan blades cannot be placed lower than 2,3m from the floor.

- The installation site must have an all-pole switch with a minimum separation gap of 3 mm.

DO YOU NEED HELP?

To install a ceiling fan, be sure you can do the following:

- Locate ceiling joist or other suitable support in ceiling.
- Drill holes for and install wood screws.
- Identify and connect electrical wires.
- Lift 16 kg.

If you need help installing the fan, your Hunter fan dealer can direct you to a licensed installer or electrician.



STEP 1 - GETTING READY

GATHERING THE TOOLS

You need the following tools to install the fan:

- Electric drill with 9/64" bit and masonry bit
- Standard screwdriver
- Phillips-head screwdriver
- Wrench or pliers
- Two M5 x 30 mm expansion anchors (for concrete ceilings only)

OPTIONAL ACCESSORIES

Consider using Hunter's optional accessories, such as a wall-mounted or remote speed control. Follow the instructions for installation and use included with each Hunter accessory.

For quiet and optimum performance of your Hunter fan, use only Hunter speed controls.

PREPARING THE FAN SITE

Reliable operation, efficiency, and maximum energy savings depend upon proper placement and attachment of the fan. For this reason, we have included a separate booklet — "Guide to Choosing and Preparing a Ceiling Fan Site" — to help you select the best location for your fan. The booklet also provides information to ensure your fan support and electric outlet box meet UL-approved safety codes for ceiling fans.

The instructions in this installation manual assume that you have used the "Guide to Choosing and Preparing a Ceiling Fan Site" to pick the fan location and make certain the proper fan support and outlet box are installed.

CHECKING YOUR FAN PARTS

Carefully unpack your fan parts to avoid damage. Check for shipping damage. If one of the fan blades is damaged, return all blades for replacement.

Hint: If installing more than one fan, keep the fan blades in sets, as shipped.

EASY LOCK™ BLADE SYSTEM

Your new Hunter ceiling fan includes our exclusive Easy Lock™ blade assembly which locks the blades in place without tools and eliminates up to 40 parts. It also allows easy removal of the blades for cleaning.



Flush Mounting (Figure 1a) fits close to the ceiling, for low ceilings less than 2,6 m high.

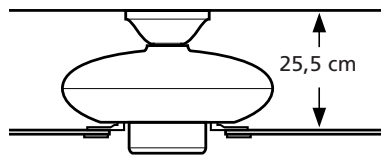

Figure 1a - Flush Mounting

Standard Mounting (Figure 1b) hangs from the ceiling by a connector pipe (included), for ceilings 2,6 m or higher. For ceilings higher than 2,6 m, you can also purchase Hunter extension rods. All Hunter fans use sturdy 2 cm inner diameter pipe to assure stability and wobble-free performance.

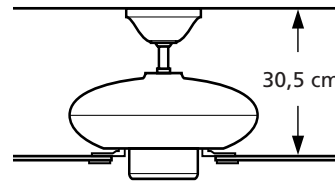

Figure 1b - Standard Mounting

Angle Mounting (Figure 1c) hangs from a vaulted or angled ceiling.

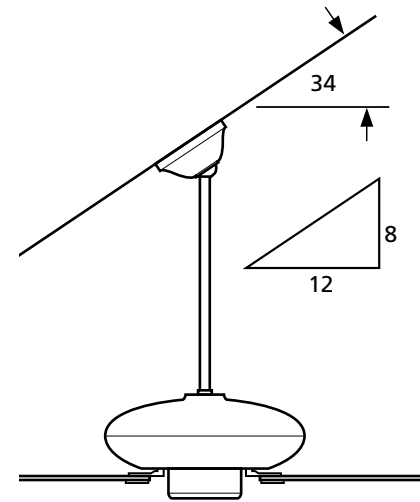

Figure 1c - Angle Mounting



STEP 2 - INSTALLING THE CEILING PLATE

WARNING

- To avoid possible electrical shock, before wiring fan, disconnect power by turning off the circuit breakers both to the outlet box and to its associated wall switch location. If you cannot lock the circuit breakers in the off position, securely fasten a prominent warning device, such as a tag, to the service panel.
- All wiring must be in accordance with national and local electrical codes. If you are unfamiliar with wiring, you should use a qualified electrician.

1. Drill two pilot holes into the wood support structure through the outermost holes on the outlet box. The pilot holes should be $9/64$ " in diameter and $4\ 1/4$ " (110mm) apart. See Figure 2a.
2. Insert the 3 rubber isolators into the 3 round holes in the ceiling plate as shown in Figure 2b. Thread the lead wires from the outlet box through the opening in the middle of the ceiling plate.
3. Align two opposing oval slots in the ceiling plate with the pilot holes in the wood support structure. See Figure 2b.

ANGLE MOUNTING

For Angle Mounting be sure to orient the Ceiling Plate so that the arrows marked on the plate are pointing towards the ceiling peak. See Figure 2b.

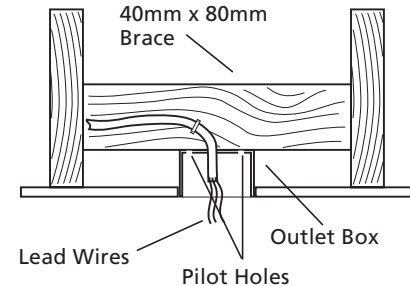

Figure 2a - Pilot Holes and Outlet Box location

4. Place a flat washer on each of the two 3" wood screws and pass the screws through two opposing oval slots in the ceiling plate, as shown in Figure 2c. You may substitute the 3" wood screws with the provided $1\ 1/2$ " wood screws for shorter depth installations. Be sure that enough of the screws enters the mounting surface to support the assembled fan.

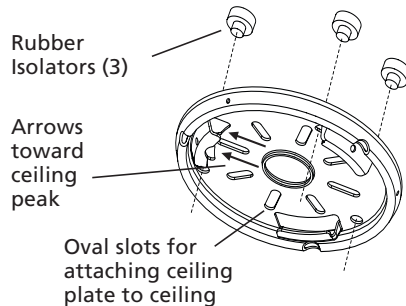

Figure 2b - Correct Position of Ceiling Plate for Angle Mounting and location of rubber isolators.

5. Tighten the screws into the 9/64" pilot holes.

Note: The rubber isolators in the ceiling plate should be compressed against the ceiling. Do not over-tighten.

FOR CONCRETE CEILINGS

1. Locate the electrical supply mains in the ceiling.

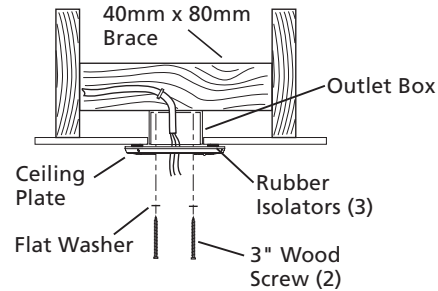

Figure 2c - Attaching Ceiling Plate to 40 mm x 80 mm Brace

- Note:** You must purchase the expansion anchors separately. Drill the holes in the ceiling to the depth and diameter recommended by the manufacturer of the expansion anchors.
2. Drill two holes 110 mm (4,32") apart on either side of the mains as shown in Figure 2d. The holes are for M5 x 30 mm expansion anchors.

3. Drive the expansion anchors into the holes until the ends of the anchors are flush with the ceiling. See Figure 2e.

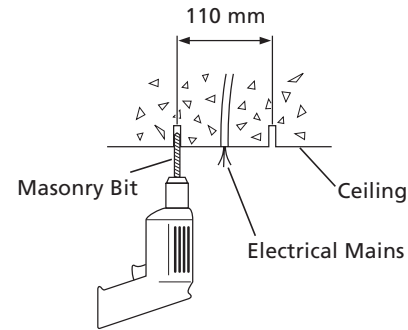

Figure 2d - Drilling Anchor Holes

4. Hold the Ceiling Plate up to the ceiling and align two opposing oval slots in the Ceiling Plate with the expansion anchors. See Figure 2b. Be sure that the electrical mains protrude through the center opening in the Ceiling Plate by at least 150 mm.

continued



5. Drive the M5 x 30 mm screws into the anchors so that the Ceiling Plate is tight against the ceiling. See Figure 2f.

Note: The rubber isolators in the Ceiling Plate should be compressed against the ceiling. Do not overtighten.

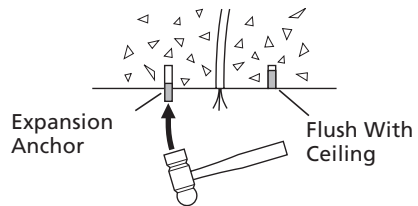

Figure 2e - Driving Expansion Anchors into Holes

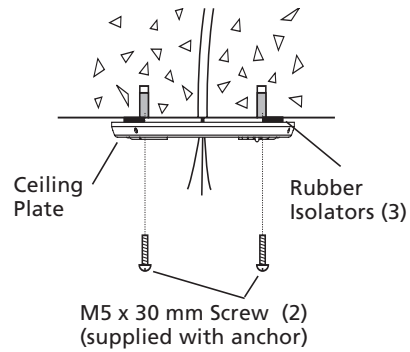

Figure 2f - Attaching Ceiling Plate to Ceiling



STEP 3 - ASSEMBLING THE FAN

WARNING

- To reduce the risk of fire, electrical shock, or motor damage, do not lift or carry the fan by the lead wires.
- To prevent damage to the wires on the bottom of the fan assembly, do not sit fan on hard surface. Use foam inside box as support.
- The pipe adapter has a special coating on the threads. Do not remove this coating; the coating prevents the pipe from unscrewing. Once assembled, do not remove the pipe.

LOW PROFILE MOUNTING

Refer to Figures 3a, 3b and 3c for the following steps.

1. Remove the Pipe Setscrew. **Note:** Save the Pipe Setscrew for possible future use in Standard or Angle Mounting. With the fan assembly resting level in the packing foam, first feed the wiring harness through the center of the upper canopy, followed by the lower canopy, then through the hanger bracket, and lastly through the low profile adapter. See figure 3a.
2. Fit the low profile adapter down inside the hanger bracket, aligning the flat section on the low profile adapter with the flat section in the hanger bracket. To clear the two screws that project into the hanger bracket, you may need to tip the flat section of the low profile adapter down slightly, while inserting it into the hanger bracket. See figure 3b.

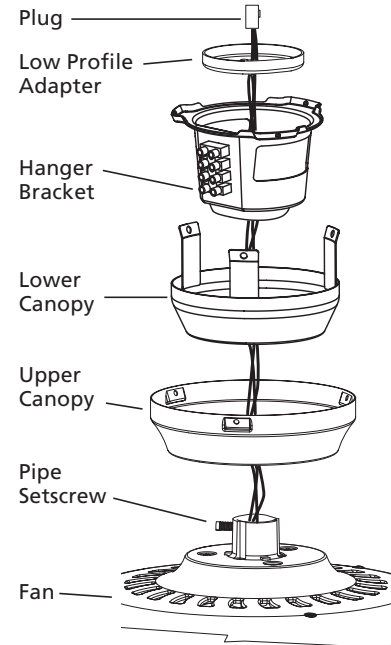

Figure 3a - Installing Low Profile Adapter

continued



3. Align the three slots in the low profile adapter with the three screw holes in the fan assembly as shown in Figure 3c. Thread one of the #8-32 x 3/4" SEMS screws into the threaded hole in the fan

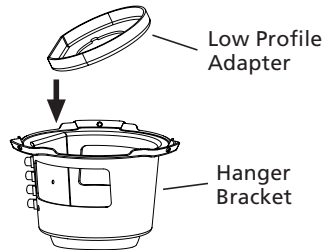

Figure 3b - inserting the low profile adapter

assembly and partially tighten it. Repeat for the other two screws. Once all three #8-32 x 3/4" SEMS screws are partially threaded into the fan assembly, center the lower canopy with the hanger bracket, making sure that the lower canopy is not captured between the fan assembly and the hanger

bracket. Tighten all three screws securely. After the three screws are tightened, the lower canopy should be free to rotate.

4. Proceed to **STEP 5 - WIRING THE FAN.**

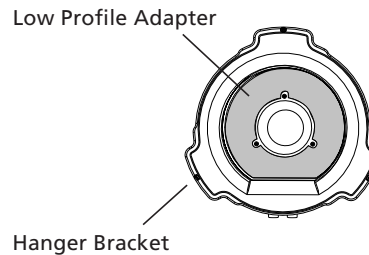

Figure 3c - Attaching the low profile adapter.

STANDARD MOUNTING AND ANGLE MOUNTING

Included with the fan are:

- one 89 mm (3 1/2") long pipe,
- one wedge

- one positioning screw located on the Trilobular™ ball assembly, and
- one locking pin.

1. With the fan assembly resting in the packing foam, feed the wiring harness from the fan through the pipe.
2. Screw pipe into fan assembly until tight.

IMPORTANT! Fully tighten pipe setscrew as indicated in Figure 3d.

3. Thread the wiring harness first through the upper canopy, the lower canopy, and then the hanger bracket, resting them on the motor housing.
4. Thread the wiring harness through the Trilobular™ ball and slide the ball onto the pipe, resting it on the fan assembly.
5. Thread the wiring harness through the wedge and slide the wedge onto the top part of the

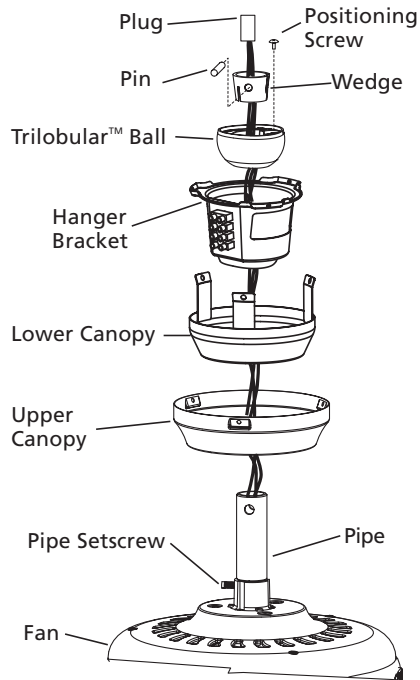

Figure 3d - Inserting Pipe through Canopy and Trilobular™ Ball

41679-01 02/16/2004

pipe. Align the openings in the wedge with the matching holes on the pipe as shown in Figure 3e. Insert the pin into the two holes in the pipe so that the pin is centered evenly in the hole, see Figure 3e.

6. Align the cutouts in the Trilobular™ ball with the pin.
7. Slide the Trilobular™ ball up the pipe until it hits the pin.
8. Insert and tighten the positioning screw into the Trilobular™ ball. See Figure 3f.

⚠ WARNING

- Failure to complete the steps above properly could result in the fan falling.

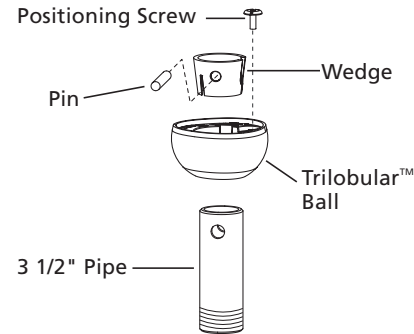

Figure 3e - Pipe & Trilobular™ Ball assembly components

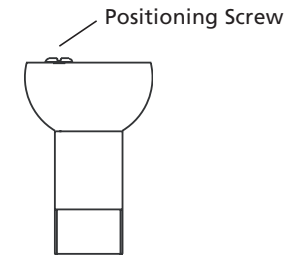

Figure 3f - Pipe, Wedge, Pin & Trilobular™ Ball assembly.



STEP 4 - INSTALLING THE BLADE IRONS

1. Turn the fan upside down. Use the ceiling fan package to support the fan while assembling the blade irons.
2. Loosen all of the blade iron assembly screws. Do not completely remove the screws.
3. Remove and discard all of the shipping blocks.
4. Slide the blade iron under the switch housing plate aligning the two notches with the two blade iron assembly screws as shown in Figure 4.
5. Pull the blade iron forward under the loosened blade iron assembly screws to fully engage the blade iron.
6. Securely tighten the blade iron assembly screws.
7. Repeat steps 4 through 6 until all blade irons are assembled.

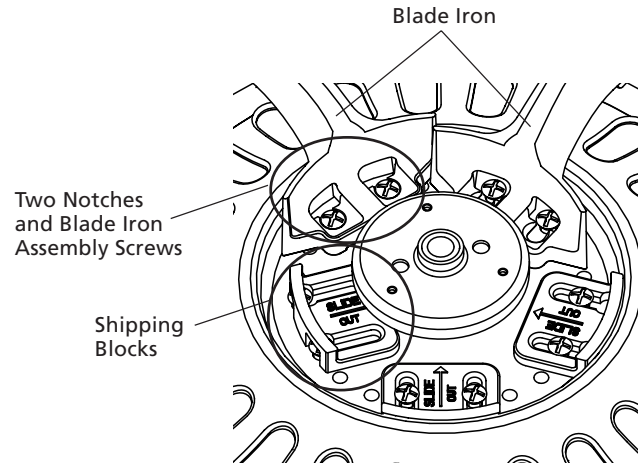

Figure 4 - Assembling the blade iron



STEP 5 - WIRING THE FAN

WARNING

- To avoid possible electrical shock, before wiring fan, disconnect power by turning off the circuit breakers both to the outlet box and to its associated wall switch location. If you cannot lock the circuit breakers in the off position, securely fasten a prominent warning device, such as a tag, to the service panel.
- All wiring must be in accordance with national and local electrical codes. If you are unfamiliar with wiring, you should use a qualified electrician.
- Failure to complete the sub steps 1-3 below could result in the fan falling.

WARNING

To reduce the risk of fire, electrical shock, or motor damage, do not lift or carry the fan by the lead wires.

1. Disconnect the power by turning off the circuit breakers to the outlet box and associated wall switch location.
2. Carefully lift the fan assembly and position the hanger bracket with the ceiling plate as shown in Figure 5a.
3. Rotate the hanger bracket until the three tabs on the hanger bracket are fully engaged in the three slots in the ceiling plate. See Figure 5b. Being careful to not allow the hanger bracket to rotate, temporarily install one of the three #6-32

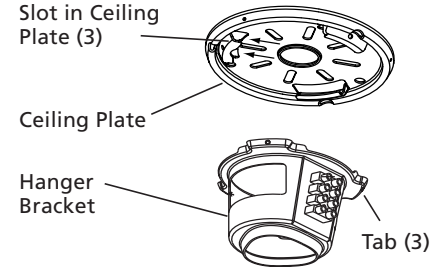

Figure 5a - Aligning the Hanger Bracket with the Ceiling Plate

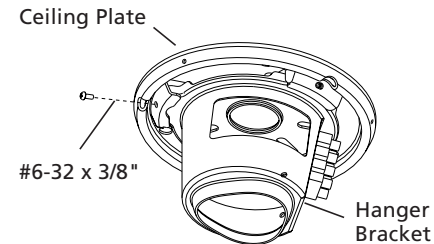

Figure 5b - Temporary installation of one #6-32 x 3/8" screw.

continued



x 3/8" screws through the hole in the ceiling plate and into the threaded hole in the hanger bracket to prevent the hanger bracket from rotating. See figure 5b.

CONNECTING FAN TO ELECTRICAL SOURCE

Use Figures 5c, 5d and 5e for reference in making the following electrical connections.

1. Connect the supply mains to the terminal block mounted on the hanger bracket.
2. Connect the safety earth (green/yellow) wire to the terminal marked .
3. Connect the blue neutral wire to the terminal marked "N."
4. Connect the brown line wire to the terminal marked "L."

Note: An additional "L" terminal is provided for separate control of the light kit, if a separate supply line is provided for that purpose.

5. Connect the motor leads to the harness assembly attached to the hanger bracket and terminal block. See Figure 5c, 5d and 5e.

Note: Unless there is a separate line for the light kit, connect the black/white wire and the brown wire from the motor housing to the same "L" terminal.

CAUTION

Be sure no bare wire or wire strands are visible after making connections.

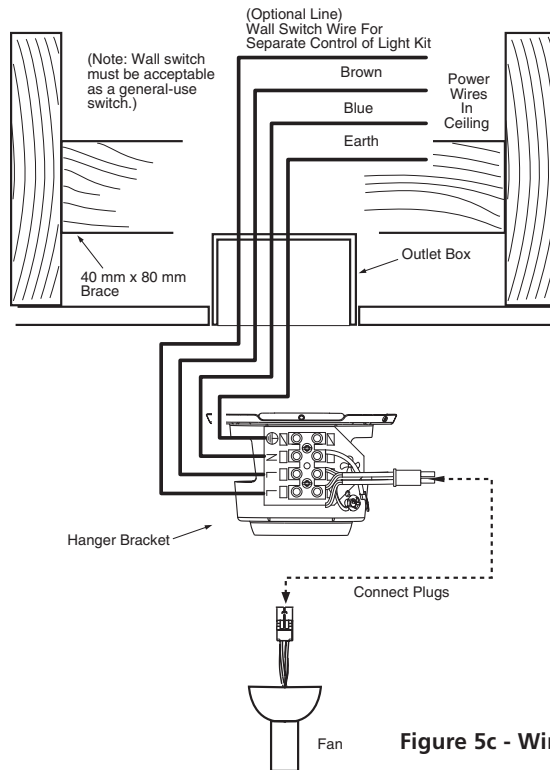

Figure 5c - Wiring Diagram

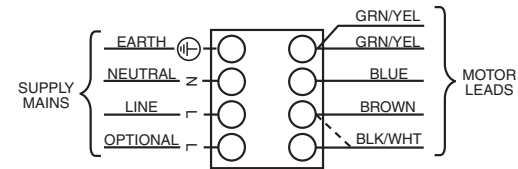

Figure 5d - Terminal Block Connections

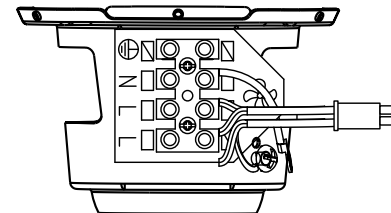

Figure 5e - Hanger Bracket & Terminal Connections



STEP 6 - INSTALLING THE CANOPY

WARNING

- When removing the #6-32 x 3/8" screw that was temporarily installed in STEP 5 - WIRING THE FAN, do not allow the hanger bracket to rotate in the ceiling plate as this could cause the fan to fall.
 - Failure to complete sub-steps 1 through 3 could cause fan to fall.
1. Being careful to not allow the hanger bracket to rotate in the ceiling plate, remove the single #6-32 x 3/8" screw that was installed in STEP 5 - WIRING THE FAN, sub step 3.

2. Raise the lower canopy up over the hanger bracket and align the three holes in the lower canopy with the three holes in the ceiling plate and the three threaded screw holes on the hanger bracket as shown in Figure 6a. You may need to slightly spread the tabs on the lower canopy to align them with the holes on the ceiling plate and hanger bracket.
3. Install and securely tighten the three #6-32 x 3/8" screws.
4. Raise the upper canopy and align the three screw holes in the upper canopy with the three threaded holes in the ceiling plate. Install and tighten the three #6-32 x 1/4" screws as shown in Figure 6b.

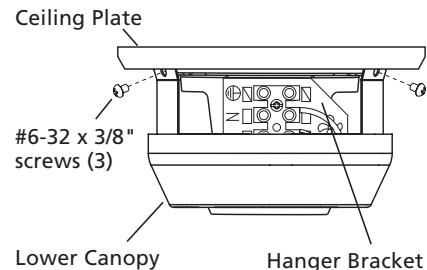

Figure 6a - Attaching Lower Canopy and Hanger Bracket to Ceiling Plate

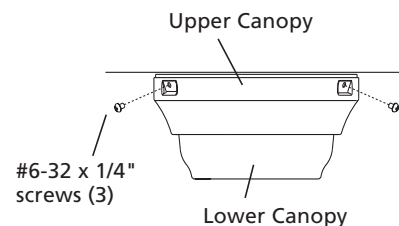

Figure 6b - Attaching Upper Canopy



STEP 7 - INSTALLING THE BLADES

1. Open the locking mechanism as shown in Figure 7a.
2. Align the holes in the blade with the blade iron as shown in Figure 7b.
3. Close the locking mechanism securely feeling it lock into place.

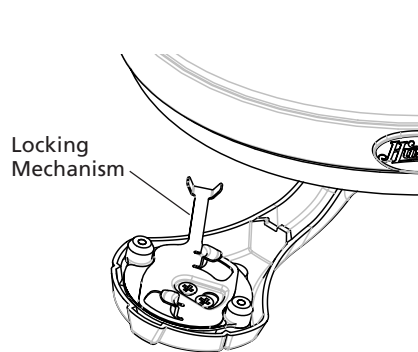

Figure 7a - Opening blade iron locking mechanism

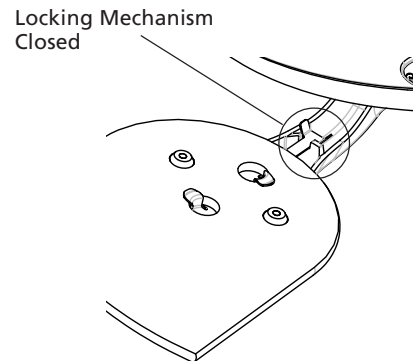

Figure 7b - Installing the blade

41679-01 02/16/2004



STEP 8 - ATTACHING THE SWITCH HOUSING

The switch housing is made up of two sections: the upper switch housing, and the lower switch housing.

ATTACHING THE UPPER SWITCH HOUSING

1. Partially install two #6-32 x 3/8" housing assembly screws into the switch housing mounting plate as shown in Figure 8a.

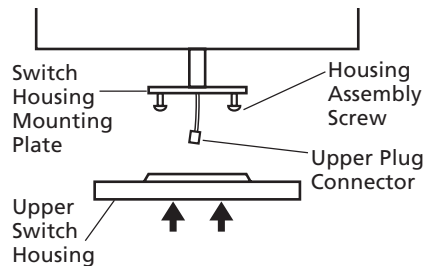

Figure 8a - Attaching Upper Switch Housing to Switch Housing Mounting Plate

2. Feed the upper plug connector through the center opening of the upper switch housing. See Figure 8a.
3. Align the keyhole slots in the upper switch housing with the housing assembly screws installed in sub-step 1.
4. Turn the upper switch housing counterclockwise until the housing assembly screws are firmly situated in the narrow end of the keyhole slots as shown in Figure 8b. Install the one remaining #6-32 x 3/8" housing assembly screw into the third hole in the upper switch housing. Tighten all three screws firmly.

CAUTION

Make sure the upper switch housing is securely attached to the switch housing mounting plate. Failure to properly attach and tighten all three housing assembly screws could result in the switch housing and light fixture falling.

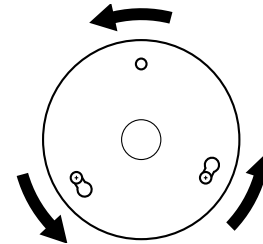

Figure 8b - Mounting the Upper Switch Housing



ATTACHING THE LOWER SWITCH HOUSING

Your hunter fan includes one of three lower switch housings. The lower switch housings are shown in Figures 8c, 8d and 8e. The type of lower switch housing you have depends on whether your fan includes a light fixture, and if so, what type of light fixture it is. Use table 8-1 to assist you.

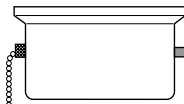

Figure 8c

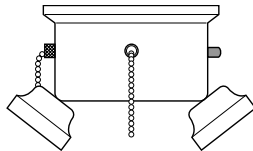

Figure 8d

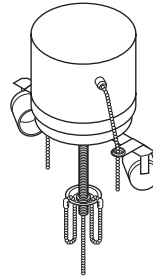

Figure 8e

If your fan has a lower switch housing as shown in Figure 8c, and you ARE installing an accessory light kit or single-globe light fixture included with your fan, go directly to STEP 9 - INSTALLING LIGHT FIXTURE.

Table 8-1

| | |
|--|---------------|
| Fan with no light fixture included | See Figure 8c |
| Fan with single-globe light fixture included | See Figure 8c |
| Fan with multi-light light fixture included | See Figure 8d |
| Fan with integrated single globe | See Figure 8e |

continued



If your fan has a lower switch housing as shown in Figure 8c and you ARE NOT installing a light fixture, or if your fan has a lower switch housing as shown in Figure 8d or 8e, complete the following steps:

1. Connect the upper plug connector from the motor to the lower plug connector in the lower switch housing assembly. See Figure 8f.

Note: Both plug connectors are polarized and will only fit together one way. Make sure that both connectors are properly aligned before connecting them together. Incorrect connection could cause improper operation and damage to the product.

2. Place the lower switch housing assembly over the upper switch housing. Align the side screw holes in the upper and lower

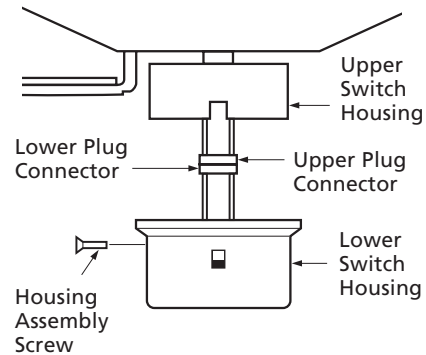

Figure 8f

switch housings. Attach the lower switch housing to the upper switch housing with three #6-32 x 3/8" housing assembly screws. See Figure 8f.

Note: If your fan does not include a light fixture, you may purchase an accessory light kit separately. See STEP 9 - INSTALLING LIGHT FIXTURE.



STEP 9 - INSTALLING LIGHT FIXTURE

Your fan may include a light fixture. Information for installing all included Hunter light fixtures follows.

If your fan comes with the light fixture already attached to the lower switch housing, to install the glass globe(s), refer to the sub step titled **INSTALLING GLASS GLOBES**.

If you are not installing a light fixture, turn to **OPERATING YOUR HUNTER FAN** for additional instructions.

WARNING

- To avoid possible electrical shock, before installing light fixtures, disconnect power by turning off the circuit breakers both to the outlet box and to its associated wall switch location. If you cannot lock the circuit breakers in the off position, securely fasten a prominent warning device, such as a tag, to the service panel.
- Connect house wiring to the fan before attaching the light fixture to the fan.
- All wiring must be in accordance with national and local electrical codes. If you are unfamiliar with wiring, you should use a qualified electrician.

INSTALLING GLASS GLOBES

INSTALLING SINGLE-GLOBE FIXTURE BULB AND GLOBE

Refer to Figure 9a.

1. Install light bulbs.
2. Insert the globe around the bulb and into the fixture. Install and tighten thumbscrews manually. Do not overtighten.

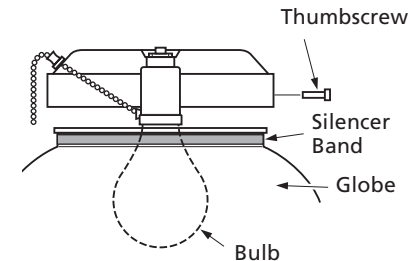

Figure 9a - Single-Globe Fixture

continued



INSTALLING INTEGRATED MULTI-LIGHT FIXTURE BULBS AND GLOBES

Refer to Figure 9b.

1. Place silencer band around the neck of each globe.
2. Insert globe in cup.
3. Install and tighten thumbscrews manually. Do not overtighten.
4. Install bulbs.

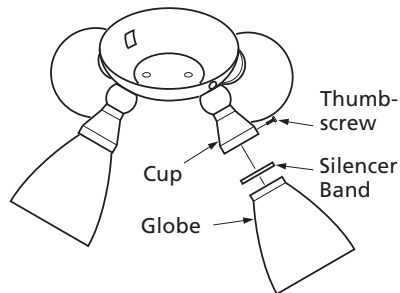

Figure 9b - Multi-Light Fixture

INSTALLING GLOBES AND BULBS

1. Place globe over threaded lampholder in cup. Install and hand tighten threaded locking ring on lampholder as shown in Figures 9c and 9d.
2. Install bulbs. Use E-27 bulb, no smaller than A-19 (60mm diameter). Turn power ON at main panel.

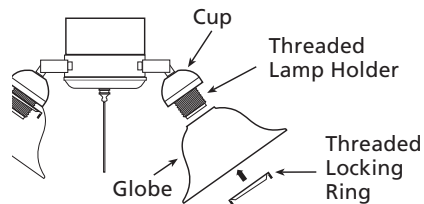

Figure 9c - Multi-Light Fixture with locking rings

Note: As shown in Figure 9d, line up the beginning of the first thread on the lamp holder and notch on the locking ring to avoid cross threading

the ring. If ring becomes hard to turn, rotate ring counter clockwise to loosen and reposition. Do not force the ring on.

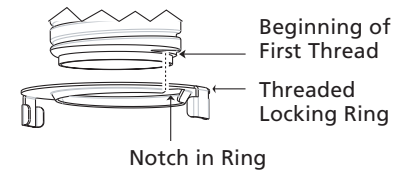

Figure 9d - Installing Locking Ring

BULB AND GLOBE ASSEMBLY

1. Install E-27 (60 W) light bulb (not included). Position the indentations in the outer rim of the glass shade so that they line up with the tabs on the inside surface of the fan light fixture rim. See Figure 9e.
2. Carefully lift the glass shade up inside the light fixture as far as it will go. Rotate the shade in a clockwise direction until it is held tightly in place by the three tabs.



CAUTION

To prevent damage to light fixture, do not sit fan on hard surface. Use foam inside box as support.

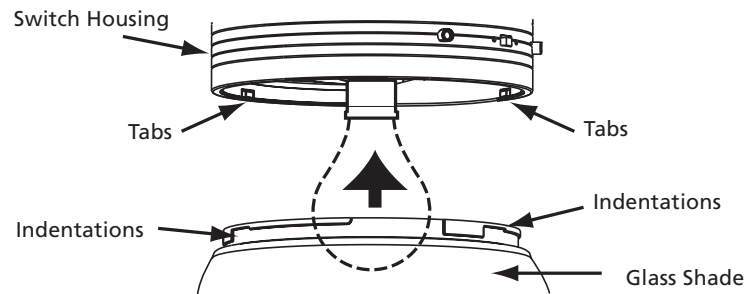

Figure 9e

INSTALLING ACCESSORY LIGHT KITS

To install the light kit, follow the instructions included with the kit for wiring, mounting, and assembly. After completing the light kit installation, follow sub-steps 1 and 2 on page 22 to reattach the lower switch housing.



OPERATING YOUR HUNTER FAN

Control switches are identified by the following symbols:

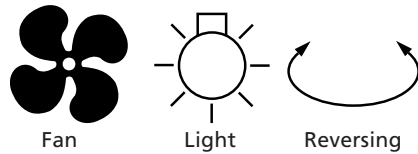

Figure 10a - Control Symbols

1. Turn on electrical power to the fan.
2. The pull chain controls power to the fan. The chain has four settings in sequence: High, Medium, Low and Off.
 - Pull the chain slowly to change settings.
 - Release slowly to prevent the chain from recoiling into the blades.

- The chain uses a breakaway connector that separates if the chain is jerked. If this happens, simply reinsert the chain into the connector.

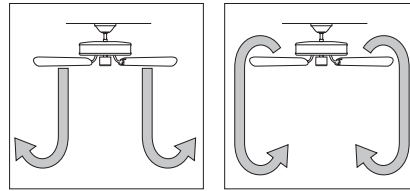

Figure 10b - Air Flow Patterns

3. Ceiling fans work best by blowing air downward (counterclockwise blade rotation) in warm weather to cool the room with a direct breeze. In winter, having the fan draw air upward (clockwise blade rotation) will distribute the warmer air trapped at the

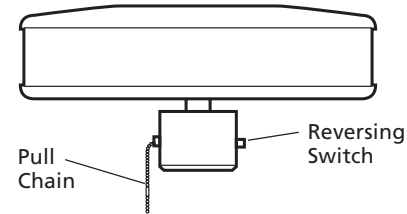

Figure 10c - Pull Chain and Reversing Switch

ceiling around the room without causing a draft.

To change the direction of air flow, turn the fan off and let it come to a complete stop. Slide the reversing switch on the fan to the opposite position as shown in Figure 10c. Restart fan.

4. If your fan wobbles when operating, use the enclosed balancing kit and instructions to balance the fan.



CLEANING AND MAINTENANCE

Caring for finishes: For cleaning, a soft brush or lint-free cloth should be used to prevent scratching the finish. A vacuum cleaner brush nozzle can remove heavier dust. Surface smudges or an accumulation of dirt and dust can easily be removed by using a mild detergent and a slightly dampened cloth. An artistic agent may be used, but never use abrasive cleaning agents as they will damage the finish.

Caring for blades: Wood finish blades should be cleaned with a furniture polishing cloth. Occasionally, a light coat of furniture polish may be applied for added protection and beauty. Painted and high-gloss blades may be cleaned in the same manner as the fan finish.

If you need parts or service assistance contact your Hunter Fan retailer or visit our WEB site at:

<http://www.hunterfan.com>



TROUBLESHOOTING

PROBLEM

Nothing happens; fan does not move.

PROBABLE CAUSE

1. Power turned off, fuse blown, or circuit breaker tripped.
2. Loose wire connections or wrong connections.
3. Motor reversing switch not engaged.
4. Pull chain switch not "on."
5. Shipping bumpers still in place.

SOLUTION

1. Turn power on, replace fuse, or reset breaker.
- 2a. Loosen canopy, check all connections according to STEP 5 - WIRING THE FAN (**turn power off before checking**).
- 2b. Check the plug connection in the switch housing according to STEP 8 - ATTACHING THE SWITCH HOUSING.
3. Push switch firmly up or down.
4. Pull switch chain.
5. Remove shipping bumpers.

Noisy operation.

1. Blade brackets screwed loosely to motor.
2. Blade screwed loosely to blade iron.
3. Blade cracked.

1. Tighten screws until snug.
2. Tighten screws until snug.
3. Replace all blades.



| PROBLEM | PROBABLE CAUSE | SOLUTION |
|---|---|--|
| Noisy operation (continued). | <ol style="list-style-type: none">Using non-approved speed control.Glass screwed loosely to fixture.Switch housing is loose. | <ol style="list-style-type: none">Change to approved speed control.Hand-tighten the light fixture screws. Ensure that rubber noise isolators are installed.Check and tighten screws to the switch housing mounting plate and to the upper and lower switch housing. |
| Excessive wobbling. Note: When switching from medium to low speed, you may notice some fan wobble. When the fan stabilizes at low speed, wobble will disappear. | <ol style="list-style-type: none">Unbalanced blades.Loose blades or blade irons.Fan not secure on hanger assembly.Fan Trilobular™ ball not seated in Hanger Bracket. | <ol style="list-style-type: none">Use balancing kit included with fan.Tighten all screws.Turn power off, support fan very carefully, loosen canopy and hang correctly.Turn power off, support the fan very carefully, and check that the Trilobular™ ball is properly seated. |

If you have tried these troubleshooting solutions and still have trouble visit our Web site at <http://www.hunterfan.com>.